

**LV**

**1400/2000**

LV1400 | LV2000MF/MM

HYUNDAI WIA Ram Type Vertical Turning Center

# Technical Leader

The CNC Turning Center LV1400/2000 Series, designed by Hyundai WIA with years of expertise and the latest technology, is designed to maximize productivity for machining large work.

		LV1400	LV2000MF/MM
Max. Swing	mm(in)	Ø1,450 (57.1")	Ø2,040 (80.3")
Max. Turning Dia.	mm(in)	Ø1,400 (55.1")	Ø2,000 (78.7")
Max. Turning Height	mm(in)	850 (33.5")	950 (37.4")/1,700 (66.9")
Table Size	mm(in)	Ø1,000 (39.4")	Ø1,600 (63")
Max. Load Capacity	kg(lb)	4,400 (9,700)	10,000 (22,046)
Spindle Speed	r/min	492	258
Spindle Power	kW(HP)	37/30 (50/40)	37/30 (50/40) [45/37 (60/50)]
Ram Size	mm(in)	200×200 (7.9"×7.9")	240×240 (9.4"×9.4")
Travel (X/Z)	mm(in)	-50~+825 (-2"~+32.5")/800 (31.5")	-250~+1,180 (-9.8~+46.5")/915 (36")

[ ] : Option

# LV

## 1400/2000

Heavy Duty, Large Work Capacity, Vertical Turning Center

- Strengthened heavy duty cutting ability with 2 step gear driven spindle(table)
- Main spindle with cross roller bearings and box guideway for high rigidity
- Rigid table structure for processing heavy loads
- 3 step hydraulic cylinder type crossrail(LV2000MM)
- Various Machining : Turning, tapping, milling, grinding etc.(LV2000MF/2000MM)
- Linear scale on all axes as standard (LV2000MF/2000MM)



# 01 BASIC STRUCTURE

Highly Rigid Bed Structure for Heavy Duty Cutting Ram Type Vertical Turning Center

## Ram Head

- Ram Size  
LV1400 : 200×200mm (7.9"×7.9")  
LV2000MF/MM : 240×240mm (9.4"×9.4")
- LV2000MM : 3 Step Crossrail

## ATC

- No. of Tools  
LV1400 : 12 [16] EA  
LV2000MF/MM : 18 [16] EA
- Tool Size (O.D/I.D)  
LV1400 :  $\varnothing 32 / \varnothing 22$ mm ( $\varnothing 1.3" / 0.9"$ )  
LV2000MF/MM :  $\varnothing 32 / \varnothing 25$ mm ( $\varnothing 1.3" / 1"$ )

## Spindle & Table

- Spindle Speed  
LV1400 : 492r/min  
LV2000MF/MM : 258r/min
- Table Size  
LV1400 :  $\varnothing 1,000$ mm ( $\varnothing 39.4"$ )  
LV2000MF/MM :  $\varnothing 1,600$ mm ( $\varnothing 63"$ )



# STRUCTURE FOR HEAVY CUTTING AND HIGH PRECISION

## HIGH-PRECISION STRUCTURE

### Highly Stable Bed Structure

LV1400/2000 is optimized for heavy duty cutting. Separate Bed Saddle structure made of cast iron minimizes vibration and thermal displacement



### Floor Space (L×W)

LV1400	LV2000MF	LV2000MM
<b>3,685×3,276</b> mm (145.1"×129")	<b>5,683×3,879</b> mm (223.7"×152.7")	<b>5,683×3,937</b> mm (223.7"×155")

## GUIDEWAY

### Hardened Plate Box Guideway

Highly rigid **hardened plate** attached box guideway increases rigidity and reduces vibration.

Also, **linear scales** on all axes provided as standard enable precise machining. (LV1400 : Option)

Rigidity **10% UP** compared to standard box guideway

### 3 Step Crossrail (LV2000MM)

3 step hydraulic cylinder crossrail(250mm (9.8"×3) enables minimization of vibration and load by extending the length of the ram depending on the machining area. This unique design allows high performance in heavy duty operations.

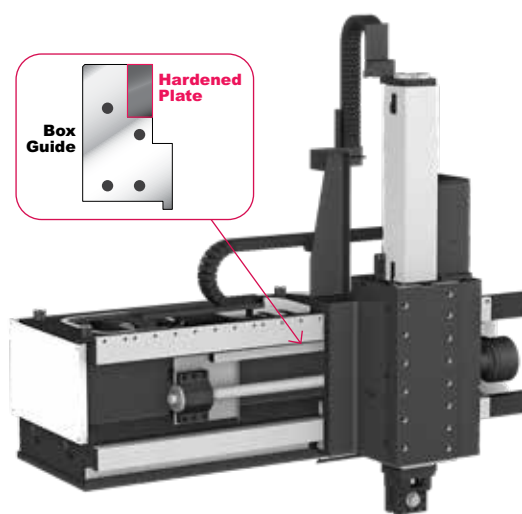
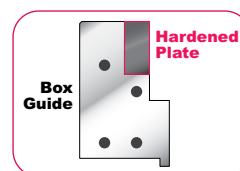

### Travel (X/Z)

LV1400	LV2000MF/MM
<b>-50~+825/800</b> mm (-2"~+32.5"/31.5")	<b>-250~+1,180/915</b> mm (-9.8~+46.5"/36")

LV1400/2000

# 02 HEAVY DUTY CUTTING

Heavy Duty, Large Work Capacity, Ram Type Vertical Turning Center

## HIGHLY RIGID TABLE

The maximum working height of **1,700mm** (66.9") - LV2000MM enables various workpiece machining.

### Table Size

LV1400

Ø1,000 mm (39.4")

LV2000MF/MM

Ø1,600 mm (63")

### Max. Turning Height

LV1400

850 mm (33.5")

LV2000MF

950 mm (37.4")

LV2000MM

1,700 mm (66.9")



# HEAVY DUTY CUTTING & HIGH ACCURACY

## SPINDLE

### Spindle for Heavy Cutting

A highly rigid cross roller bearing structure is utilized for heavy duty operations as it minimizes vibration and thermal displacement.

LV2000MF/MM includes C-axis control with ring gear and ring sensor which is superior in noise control and precision indexing than other gear box applied machines.

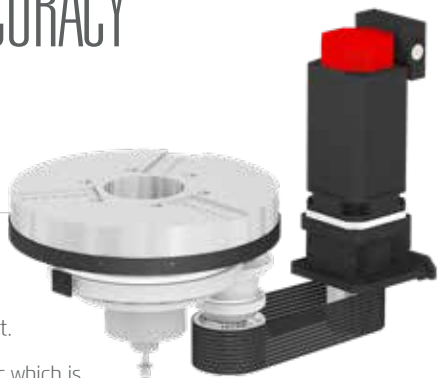

### 2 Step Gear Driven Table

2 step gear driven table provides excellent performance in all speed ranges, especially in low speed.

## RAM HEAD



Various types of machining are possible with ram head: milling with rotary tool, turning, tapping, drilling, grinding and etc.

### Improved Machining Capacity : Tapping **40% UP**

- ⦿ Live Tool Speed : **2,400** rpm
- ⦿ Max. Torque : **769** N·m (567.2 lbf·ft)

## ATC MAGAZINE

ATC is driven by a servo motor which provides faster tool change time and easier maintenance.

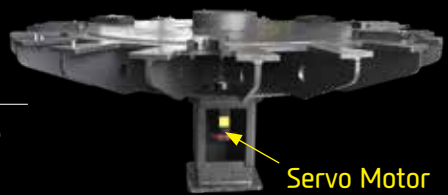

### Number of Tools

LV1400
Std. : <b>12</b> EA (Turning <b>12</b> )
Opt. : <b>16</b> EA (Turning <b>16</b> )

LV2000MF/MM
Std. : <b>18</b> EA (Turning <b>10</b> + Milling <b>7</b> + Dummy <b>1</b> )
Opt. : <b>16</b> EA (Turning <b>16</b> )

# SPECIFICATIONS

## External Dimensions

unit : mm(in)

LV1400

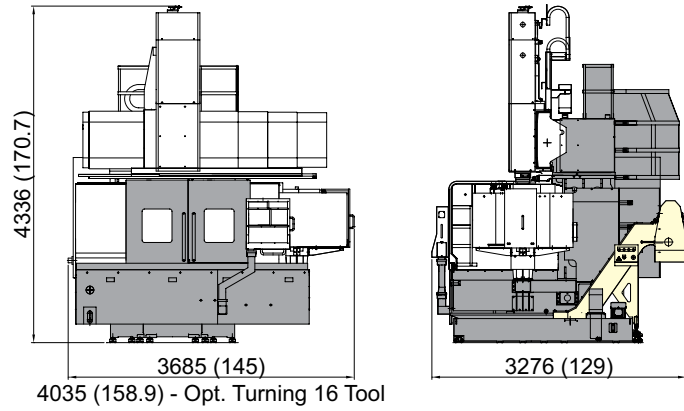

LV2000MF

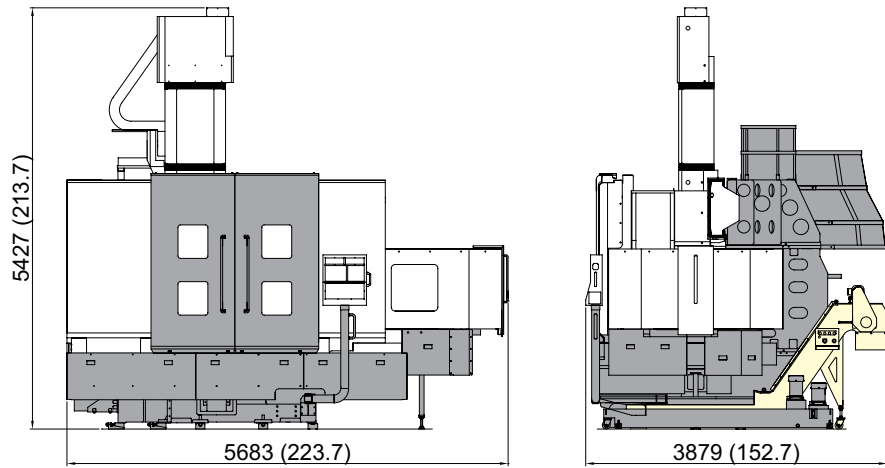

LV2000MM

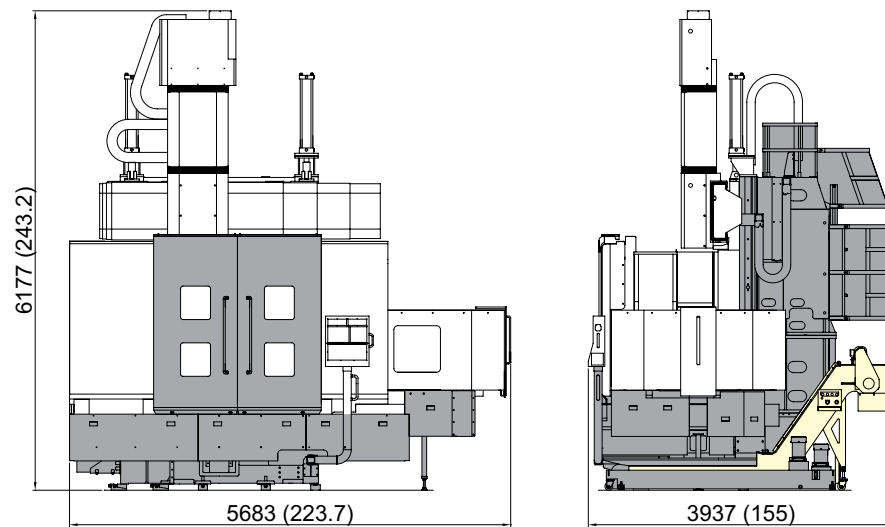



# SPECIFICATIONS

## Tooling System

unit : mm(in)

### LV1400

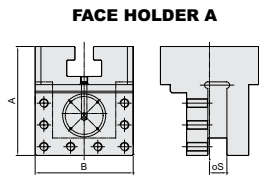

Model	A	B	S	
1084-40-203	200 (7.9)	180 (7.1)	32 (1.3)	STD.

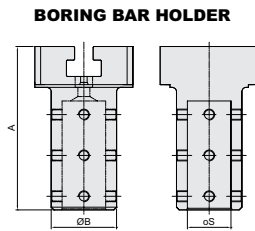

Model	A	B	S	
1084-40-204	300 (11.8)	120 (4.7)	80 (3.1)	STD.

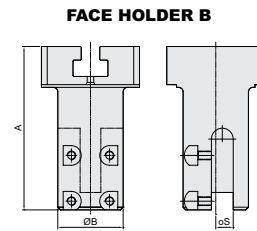

Model	A	B	S	
1084-40-205	300 (11.8)	120 (4.7)	32 (1.3)	STD.

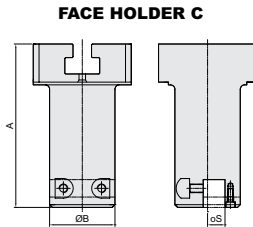

Model	A	B	S	
1084-40-206	300 (11.8)	120 (4.7)	32 (1.3)	STD.

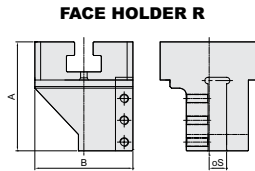

Model	A	B	S	
1084-40-210	200 (7.9)	180 (7.1)	32 (1.3)	OPT.

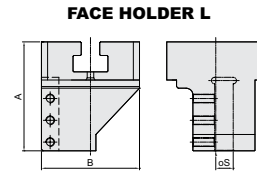

Model	A	B	S	
1084-40-211	200 (7.9)	180 (7.1)	32 (1.3)	OPT.

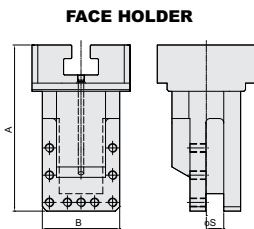

Model	A	B	S	
1084-40-212	305 (12)	142 (5.6)	32 (1.3)	OPT.

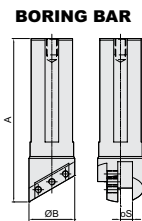

Model	A	B	S	
1084-40-207	300 (11.8)	84 (3.3)	22 (0.9)	STD.
1084-40-213	200 (7.9)	84 (3.3)	22 (0.9)	OPT.

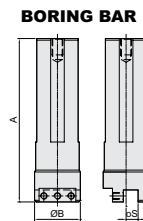

Model	A	B	S	
1084-40-208	300 (11.8)	84 (3.3)	22 (0.9)	STD.
1084-40-214	400 (15.7)	84 (3.3)	22 (0.9)	OPT.

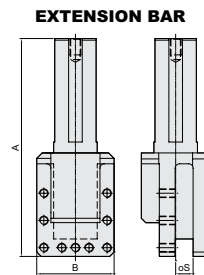

Model	A	B	S	
1084-40-209	400 (15.7)	142 (5.6)	32 (1.3)	OPT.

# SPECIFICATIONS

Tooling System

unit : mm(in)

## LV2000MF/MM

### FACE HOLDER-A

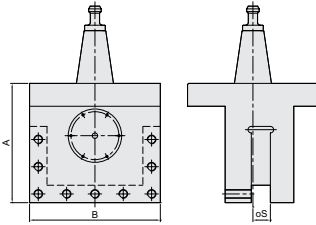

Model	A	B	S	
1085-40-201	219 (8.6)	240 (9.4)	32 (1.3)	STD.

### BORING BAR HOLDER

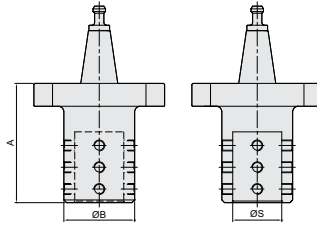

Model	A	B	S	
1085-40-204	219 (8.6)	130 (5.1)	90 (3.5)	STD.

### FACE HOLDER-B

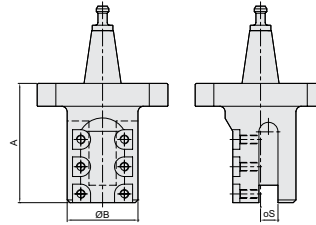

Model	A	B	S	
1085-40-202	219 (8.6)	130 (5.1)	32 (1.3)	OPT.

### FACE HOLDER-C

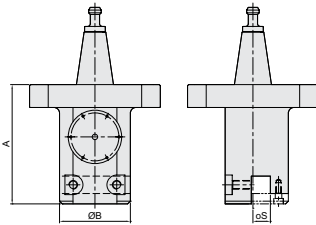

Model	A	B	S	
1085-40-203	219 (8.6)	130 (5.1)	32 (1.3)	OPT.

### FACE HOLDER-R

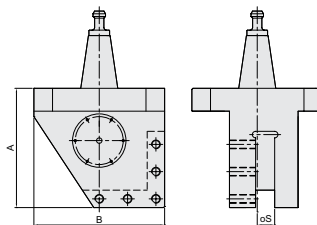

Model	A	B	S	
1085-40-206	219 (8.6)	240 (9.4)	32 (1.3)	OPT.

### FACE HOLDER-L

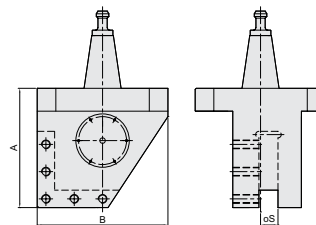

Model	A	B	S	
1085-40-205	219 (8.6)	240 (9.4)	32 (1.3)	OPT.

### CONNECTION HOLDER

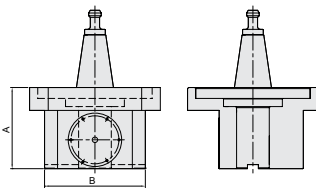

Model	A	B	S	
1085-40-209	149 (5.9)	185 (7.3)	-	OPT.

### EXTENSION HOLDER

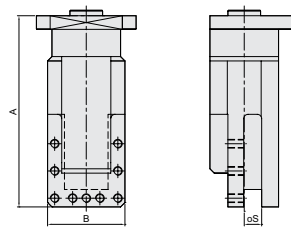

Model	A	B	S	
1085-40-208	351 (13.8)	142 (5.6)	32 (1.3)	OPT.

### BORING BAR

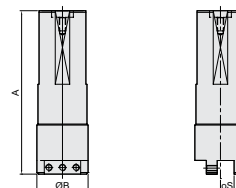

Model	A	B	S	
1085-40-305	300 (11.8)	94 (3.7)	25 (1)	STD.
1085-40-307	400 (15.7)	94 (3.7)	25 (1)	OPT.

### BORING BAR

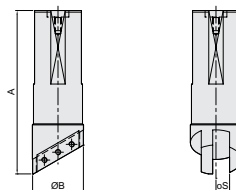

Model	A	B	S	
1085-40-306	300 (11.8)	94 (3.7)	25 (1)	STD.
1085-40-308	400 (15.7)	94 (3.7)	25 (1)	OPT.

### EXTENSION BAR

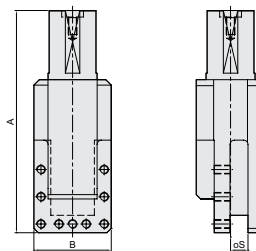

Model	A	B	S	
1085-40-207	408 (16.1)	142 (5.6)	32 (1.3)	OPT.

# SPECIFICATIONS

Tooling System

unit : mm(in)

## LV2000MF/MM



### Grinding Head

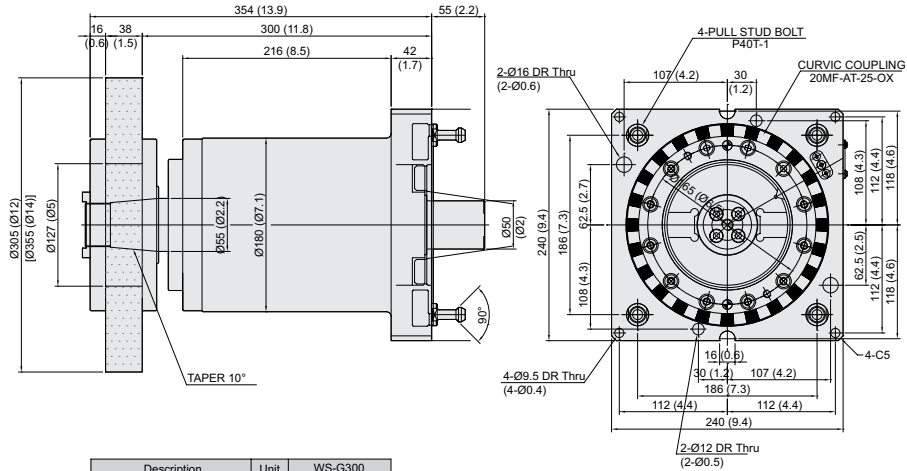

Description	Unit	WS-G300
Length	mm(in)	300 (11.8)
Max. Permissible Speed	rpm	1800
Speed Ratio(In-Out)	-	1 : 1
Lubrication	-	Grease

### Angle Head

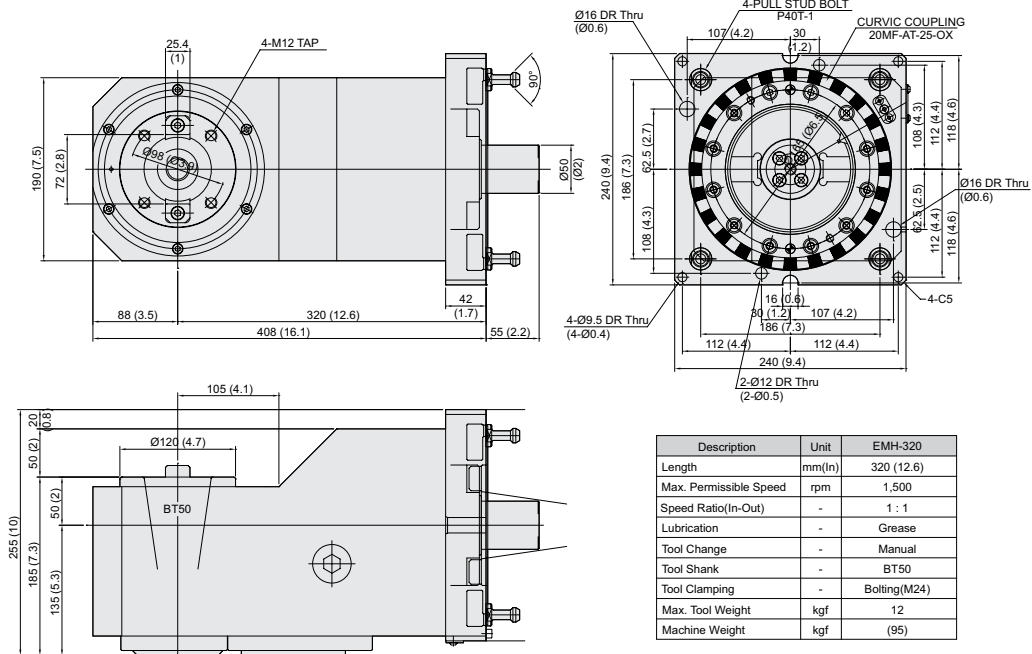

Description	Unit	EMH-320
Length	mm(In)	320 (12.6)
Max. Permissible Speed	rpm	1,500
Speed Ratio(In-Out)	-	1 : 1
Lubrication	-	Grease
Tool Change	-	Manual
Tool Shank	-	BT50
Tool Clamping	-	Bolting(M24)
Max. Tool Weight	kgf	12
Machine Weight	kgf	(95)

◆ These attachments are only applicable in mm unit.

HYUNDAI WIA  
MACHINE TOOL

LV1400/2000  
Ram Type Vertical Turning Center

10  
+  
11

EXPERIENCE  
THE NEW TECHNOLOGY

# SPECIFICATIONS

## Tooling Travel Range

unit : mm(in)

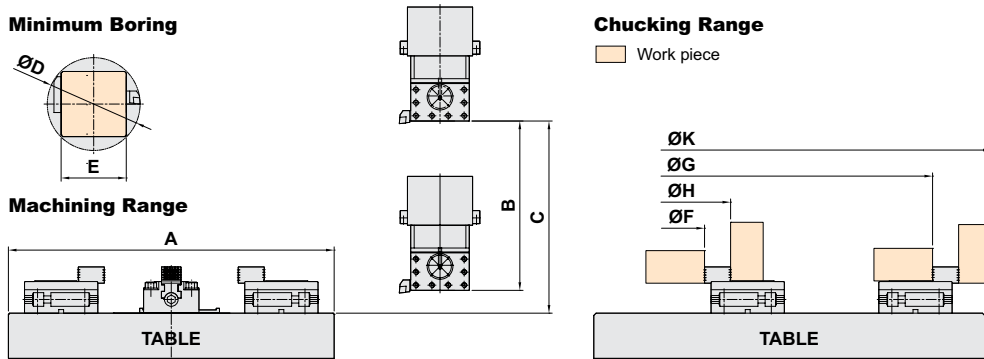

Model	A	B	C	D	E	F	G	H	K	
LV1400	1000 (39.4)	800 (31.5)	850 (33.5)	285 (11.2)	200 (7.9)	319 (12.6)	*	*	1052 (41.4)	Hydraulic Chuck (STD.)
	1000 (39.4)	800 (31.5)	850 (33.5)	285 (11.2)	200 (7.9)	220 (8.7)	890 (35)	360 (14.2)	1000 (39.4)	Independent Chuck (OPT.)
LV2000MF	1600 (63)	915 (36)	950 (37.4)	335 (13.2)	240 (9.4)	291 (11.5)	1501 (59.1)	451 (17.8)	1661 (65.4)	Independent Chuck (STD.)
LV2000MM	1600 (63)	915 (36)	MAX.1700 (MAX.67) MIN.950 (MIN.37.4)	335 (13.2)	240 (9.4)	291 (11.5)	1501 (59.1)	451 (17.8)	1661 (65.4)	Independent Chuck (STD.)

\* : The shape of soft jaw changes chucking area.

## Spindle Output/Torque Diagram

### LV1400 492rpm

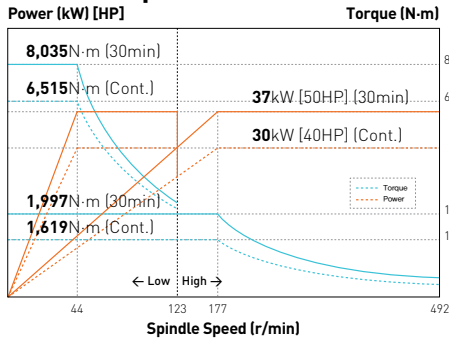

### LV2000MF/MM 258rpm

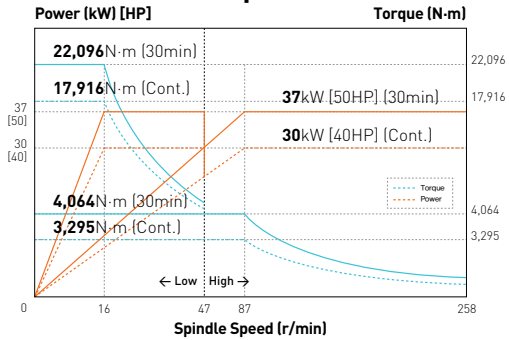

### LV2000MF/MM 258rpm

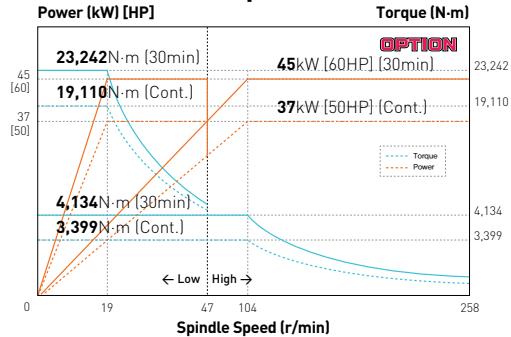

### LV2000MF/MM 2,400rpm (Mill Head)

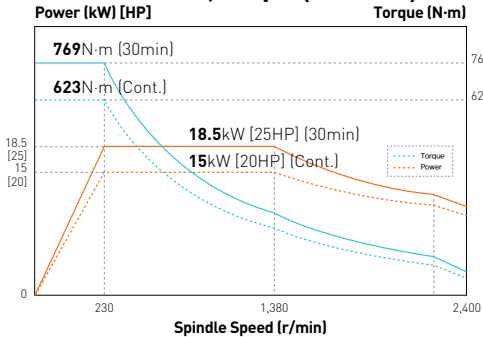

# SPECIFICATIONS

## Specifications

[ ] : Option

ITEM		LV1400	LV2000MF	LV2000MM
CAPACITY	Max. Swing	mm(in) Ø1,450 (Ø57.1")	Ø2,040 (Ø80.3")	
	Max. Turning Dia.	mm(in) Ø1,400 (Ø55.1")	Ø2,000 (Ø78.7")	
	Max. Turning Height	mm(in) 850 (33.5")	950 (37.4")	1,700 (66.9")
	Max. Load Capacity	Kg(lb) 4,400 (9,700)	10,000 (22,046)	
FEED	X-Axis	mm(in) -50 ~ +825 (-2"~+32.5")	-250 ~ +1,180 (-9.8"~+46.5")	
	Z-Axis	mm(in) 800 (31.5")	915 (36")	
	C-Axis	deg -	360	
	W-Axis	mm(in) -	250 (9.8")×3 Steps	
RAPID TRAVERSE RATE	X/Z-Axis	m/min(ipm) 12/12 (472/472)		
	C-Axis	deg/min -	750	
RAM HEAD	Ram Size	mm(in) 200 (7.9")	Turning 240 (9.4") (Milling BT50)	
	Live Tool Speed	r/min -	2,400	
	Live Tool Power (Max./Cont.)	kW(HP) -	18.5/15 (25/20.1) [High Torque Motor]	
	Live Tool Torque	N-m (lb-ft) -	769 (567.2)	
TABLE	Table Size	mm(in) Ø1,000 (Ø39.4")	Ø1,600 (Ø63")	
	Table Speed	r/min 492	258 [258]	
	Table Max. Torque	N-m (lb-ft) 8,035 (5,926.3)	22,096 (16,297.2) [23,242 (17,142.4)]	
	Table Power (Max./Cont.)	kW(HP) 37/30 (50/40)	37/30 (50/40) [45/37 (60/450)]	
ATC	Number of Tools	EA 12 [16] (Turning 12 [16])	18 (Turning 10 + Milling 7 + Dummy 1) [16 (Turning 16)]	
	Tool Size	OD./ID. mm(in) □32 (□1.3")/□22 (□0.9")	□32 (□1.3")/□25 (□1")	
POWER	Electric Power Supply	kVA 45	65	
MACHINE	Floor Space (L×W)	mm(in) 3,685×3,276 (145.1"×129")	5,683×3,879 (223.7"×152.7")	5,683×3,937 (223.7"×155")
	Height	mm(in) 4,336 (170.7")	5,427 (213.7")	6,177 (243.2")
	Weight	kg(lb) 14,500 (31,967)	25,000 (55,116)	29,000 (63,934)
NC	Controller	-	FANUC 32i-A	

※ Prior consultation is required when applying spindle contouring control for gear driven spindle.

◆ LV2000MF/MM : Only Turning Type

## Standard & Optional

LV1400	
Standard	40" 3 Jaw Hydraulic Chuck   Soft Jaw(1set)   Chuck Clamp Foot Switch   Chuck Open/Close Confirmation Device   Standard Tool Holder Standard Coolant (Nozzle)   Bed Flushing   Coolant Tank   Front Door Inter-Lock   3 Color Call Light   Work Light   Leveling block   Foundation Bolt & Nut
Option	50" 4 Jaw   Independent Chuck   50" 4 Jaw Hydraulic Chuck   Gun Coolant   Chip Conveyor (Hinge)   Chip disposal : Rear, Right   Chip Wagon (Standard 180 ℓ [47.5 gal] Swing 200 ℓ [52.8 gal] Large Size 330 ℓ [87.2 gal])   Q-setter   Air Conditioner   Oil Skimmer   3 Color Call Light & Buzzer   Transformer   Auto Power Off   X, Z Axis Linear Scale   High Column 200mm (7.9")   Air Gun
LV2000MF/MM	
Standard	63" Manual Table   Chuck JAW 4set   Standard Tool Holder   Standard Coolant (Nozzle)   SP, Thru Coolant (10bar [145 psi])   Air Gun   Coolant Tank   Front Door Inter-Lock   3 Color Call Light   Work Light   Leveling block   Foundation Bolt & Nut   X,Z Axis Linear Scale   Bed Flushing
Option	SP, Thru Coolant (20bar [290 psi])   Gun Coolant   Chip Conveyor (Hinge)   Chip disposal : Rear, Right   Chip Wagon (Standard 180 ℓ [47.5 gal] Swing 200 ℓ [52.8 gal] Large Size 330 ℓ [87.2 gal])   Q-setter   Air Conditioner   Oil Skimmer   3 Color Call Light & Buzzer   Transformer   Auto Power Off   Mill Removal

## Standard Tool Holder

LV1400	1084-40-203: FACE HOLDER A(2EA)	1084-40-204: BORING BAR HOLDER (2EA)
	1084-40-205: FACE HOLDER B(1EA)	1084-40-206: FACE HOLDER C(1EA)
	1084-40-207: BORING BAR(1EA)	1084-40-208: BORING BAR(1EA)
LV2000MF/MM	1085-40-201: FACE HOLDER A(2EA)	1085-40-204: BORING BAR HOLDER (2EA)
	1085-40-305: BORING BAR (1EA)	1085-40-306: BORING BAR (1EA)

Specifications are subject to change without notice for improvement.

# CONTROLLER

## FANUC 32i-A

Axis control / Display unit	
Controlled axes	Max. 4 axes are available X, Z axes X, Z, C axes (M type machine) X, Z, Y, C axes (Y type machine) X, Z, B, C axes (MS type machine)
Simultaneous controllable axes	2axes / Linear and circular (Max. 4axes)
Least input increment	X, Z, Y, B axes : 0.001 mm (0.0001") C axis : 0.001 deg
Least command increment	X, Z, Y, B axes : 0.001 mm (0.0001") C axis : 0.001 deg
High speed HRV control	
Inch / Metric conversion	G20 / G21
Interlock	Each axis / All axes
Machine lock	All axes
Emergency stop	
Stored stroke check 1	Over-travel
Stored stroke check 2	
Stored stroke check 3	
Follow-up	
Servo-off	
Backlash compensation	+/- 0~9999 pulses (Rapid traverse & cutting feed)
Position switch	
Unexpected disturbance torque detection	Back-spin torque limiter (BST)
High resolution transfer control (HRM)	
LCD / MDI	10.4" Color LCD
Operation	
Automatic operation (memory)	
MDI operation	
Search function	Sequence, program
Program restart	
Wrong operation prevention	
Buffer register	
Program check function	Dry run., program check
Single block	
Feed functions	
Manual jog feed	Rapid, jog, handle
Manual handle feedrate	x1, x10, x100
Feed command	F code feedrate direct command
Feedrate override	0~200 % (10% units)
Jog override	0~2,000 mm/min[79 ipm]
Rapid traverse override	F1, F5, F25/F50, F100%
Override cancel	
Feed per minute / rotation	
Program input & interpolation functions	
Nano interpolation	Positioning / Linear / Circular (G00 / G01 / G02, G03)
Dwell	G04, 0~9999.9999 sec
Thread retract	
Variable lead threading	
1st reference point return	G28, manual
Reference point return check	G27
2nd reference point return	G30
Program stop / End	M00, M01 / M02, M30
Tape code	EIA / ISO
Optional block skip	1 ea
Maximum programmable dimensions	+/- 9999.9999"
Program number	0+4 digits
Absolute and incremental programming	
Decimal point input	
Plane selection	G17, G18, G19
Work coordinate system selection	G52 to G59
Manual absolute	"ON" Fixed
G code system	A
Programmable data input	G10
Sub program call	10 folds nested
Custom macro B	

Program input & interpolation functions	
Addition of custom macro common variable	#100 to #199, #500 to #999
Multiple repetitive cycles	
Multiple repetitive cycles II	
Canned cycles for turning	
Manual guide i	Conversational programming
Sub / Main spindle function	
M-Code function	M 4 digits
M-Code function lock	
Lock sp. speed command	S 4 digits, binary output
Main sp. constant control	G96, G97
Spindle speed override	50% to 150% (10% units)
Spindle position decision	
Rigid tapping	
Tool function / Tool compensation	
Tool function	T2 + 2
Tool offset pairs	64 pairs
Tool offset	
Tool nose radius compensation	G40, G41, G42
Direct input of measured tool compensation value B	
Tool life management	
Data in/output & editing functions	
Reader / Puncher interface	RS232C
Memory card input/output	
Part program storage length	256 Kbyte
Number of registrable programs expansion	Max. 500 programs
Memory lock	
Background editing	
Extended part program edition	Copy, move, change of NC program
Display, diagnosis & setting functions	
Self-diagnosis function	
History display	Alarm & operation display
Help function	
External message	
Run hour / Parts count display	
Display of actual spindle speed and T code	
Actual cutting feedrate display	
Operating monitor screen	Rod meter light
Graphic display	
Spindle / Servo setting screen	
Selection of 5 optional language	
LCD screen display	Screen saver
Automatic data backup	
Functions according to machine specification	
Cs contouring control	Turn mill
Stored pitch error compensation	Turn mill
Polar coordinate interpolation	Turn mill
Cylindrical interpolation	Turn mill
Canned cycles for drilling	Turn mill
spindle orientation expansion	Turn mill, Sub spindle
Spindle synchronous control	Sub spindle
Torque control	Sub spindle
Y axis offset	Y type machine
Angular axis control	Y type machine
Option	
High speed Ethernet	100 Mbps (Option board is required)
Optional block skip	9 ea
3rd & 4th reference point return	
G code system	B / C
Part program storage length	512 Kbyte
Polygon turning	
Helical interpolation	
Dynamic graphic display	
Protection of data at 8 levels	
Direct drawing dimension programming	Included chamfering / Corner R'

Figures in inch are converted from metric values.

The FANUC controller specifications are subject to change based on the policy of company CNC supplying.

# HW-MMS

HYUNDAI WIA Machine Monitoring System



A manufacturing machine self-developed by Hyundai Wia, HW-MMS is a unique software capable of monitoring the operation status of manufacturing machines in factories, a smart solution to improve manufacturing conditions of customers

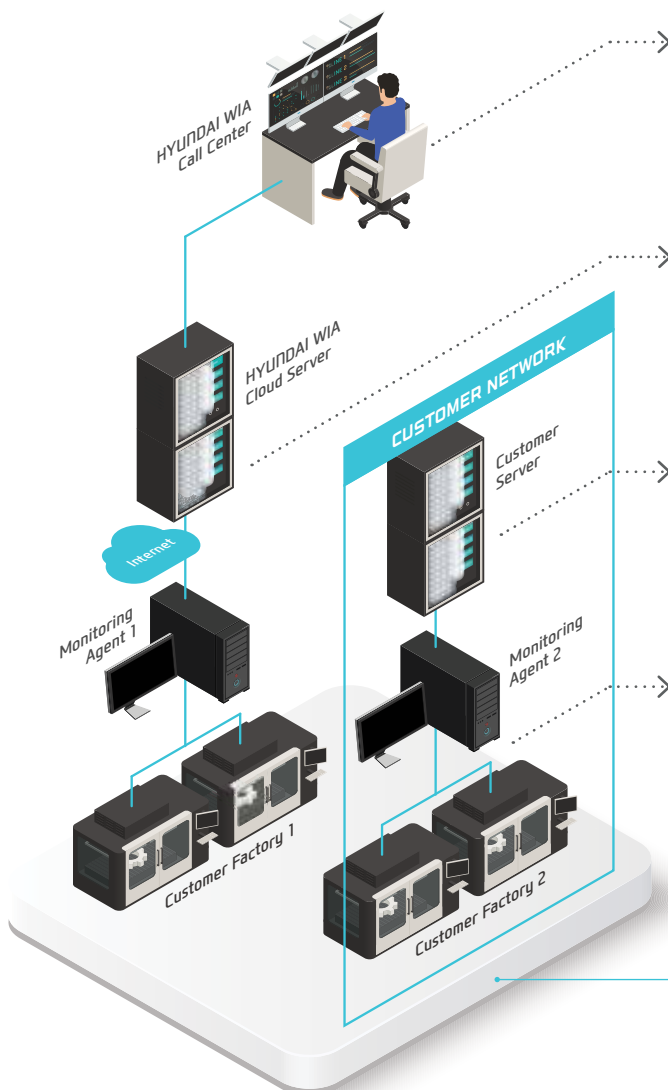

### HW-MMS Remote

Hyundai Wia Call Center's remote diagnosis service provides a HMI/video diagnostic function.



### HW-MMS Cloud

A cloud server-based equipment monitoring system for collecting and analyzing facility operation data.



### HW-MMS Edge

A client server-based tool monitoring system for collection/analysis of facility operation data. (Compatible with client MES / ERP interface)



### HW-MMS Edge Plus

This is a facility big data-based smart factory solution that collects and analyzes spindle/feed data, tool lifespan, PC processing files, etc. in real time

HYUNDAI WIA  
Smart Factory Solution



LV1400  
Movie



LV2000MM  
Movie



**You Tube** HYUNDAI WIA MT

[www.youtube.com/HYUNDAIWIAMT](http://www.youtube.com/HYUNDAIWIAMT)

## EXPERIENCE THE NEW TECHNOLOGY

With its top-quality HYUNDAI WIA machine tool creates a new and better world.



<http://machine.hyundai-wia.com>

HYUNDAI WIA Machine Tools  
Global Links

### HEADQUARTER

**Changwon Technical Center/R&D Center/Factory** 153, Jeongdong-ro, Seongsan-gu, Changwon-si, Gyeongsangnam-do, Korea TEL : +82 55 280 9114 FAX : +82 55 282 9114

**Overseas Sales Team /R&D Center** 37, Cheoldobangmulgwan-ro, Uliwang-si, Gyeonggi-do, Korea TEL : +82 31 8090 2539

### OVERSEAS OFFICES

**HYUNDAI WIA Machine America corp.** 450 Commerce Blvd, Carlstadt, NJ 07072, USA TEL : +1-201-987-7298

**HYUNDAI WIA Europe GmbH** Alexander-Fleming-Ring 57, 65428 Rüsselsheim Germany TEL : +49-0-6142-9256-0

**HYUNDAI WIA Machine Tools China** 2-3F, Bldg6, No.1535 Hongmei Road, Xuhui District, Shanghai, China TEL : +86-21-6427-9885

**India Branch Office** #4/169, 1st Floor, LOTTE BLDG, Rajiv Gandhi Salai, (OMR), Kandanchavadi, Chennai - 600096, Tamilnadu, India TEL : +91-76-0490-3348

**Vietnam Branch Office** Flat number 05, Service and Trade Center of Viet Huong Industrial Zone, Highway 13, Thuan Giao, Thuan An, Binh Duong, Vietnam TEL : +84-3-5399-5099

2021-06 001.003 ENG